

wood luck

River

Bookcase / Regal

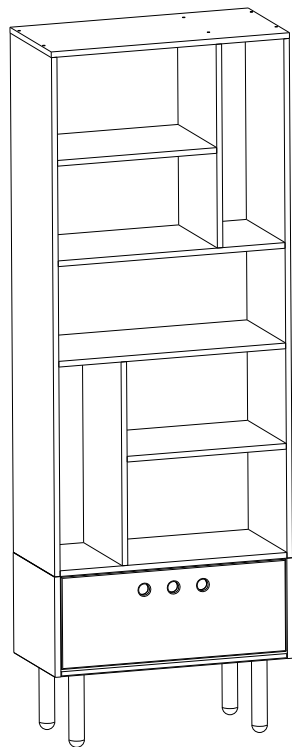

65cm x 185cm x 32cm

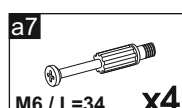
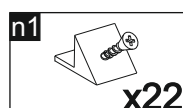
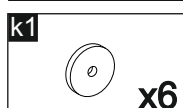
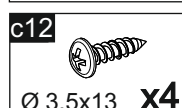
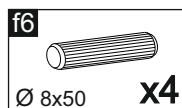
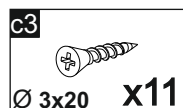
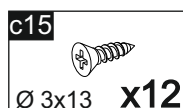
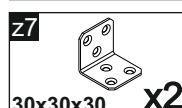
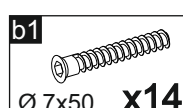
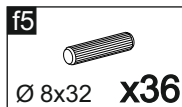
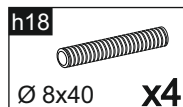
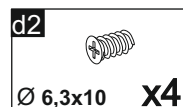
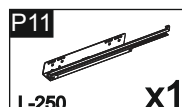
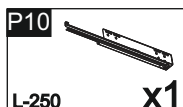
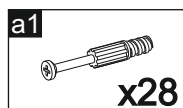
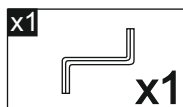
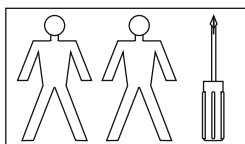

1/20

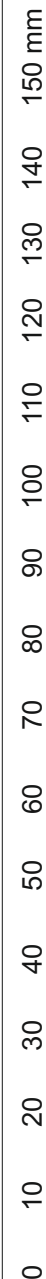
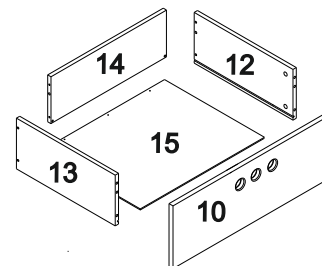
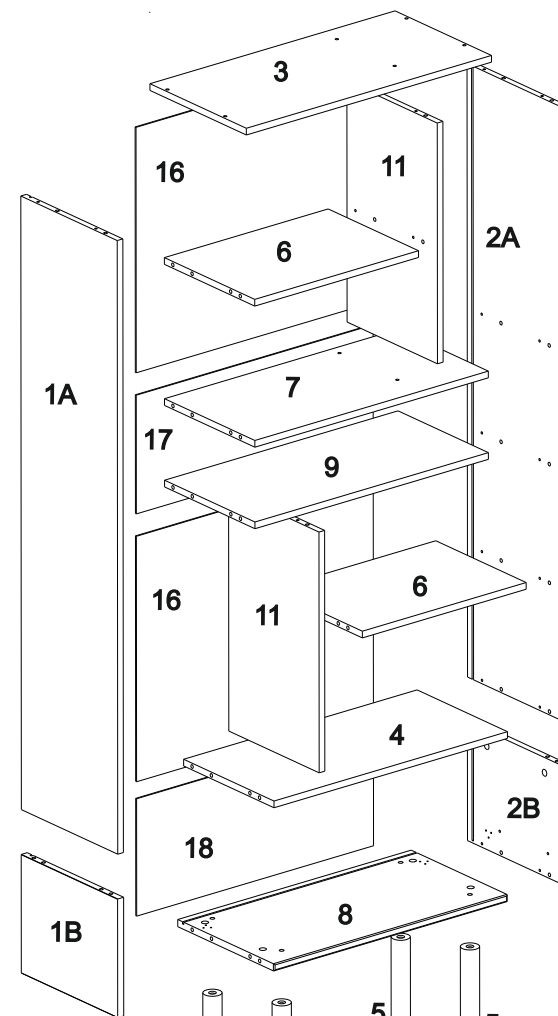
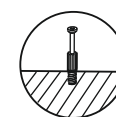
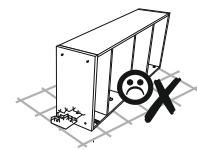
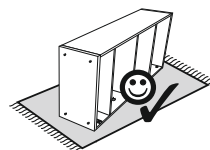

2/20

1

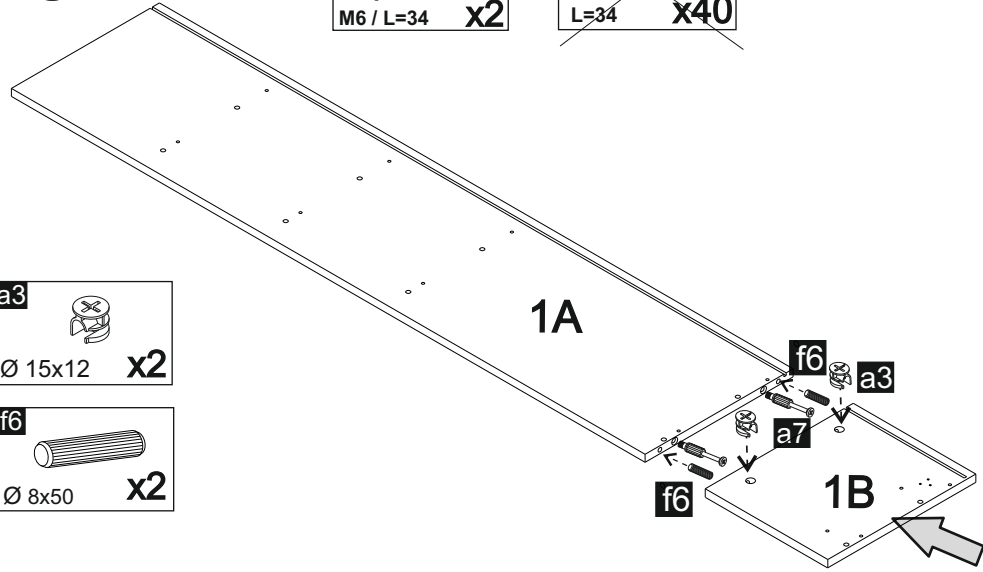
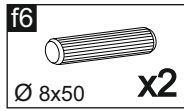
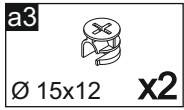
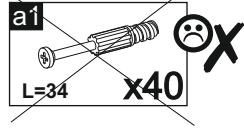
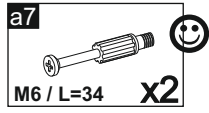

3

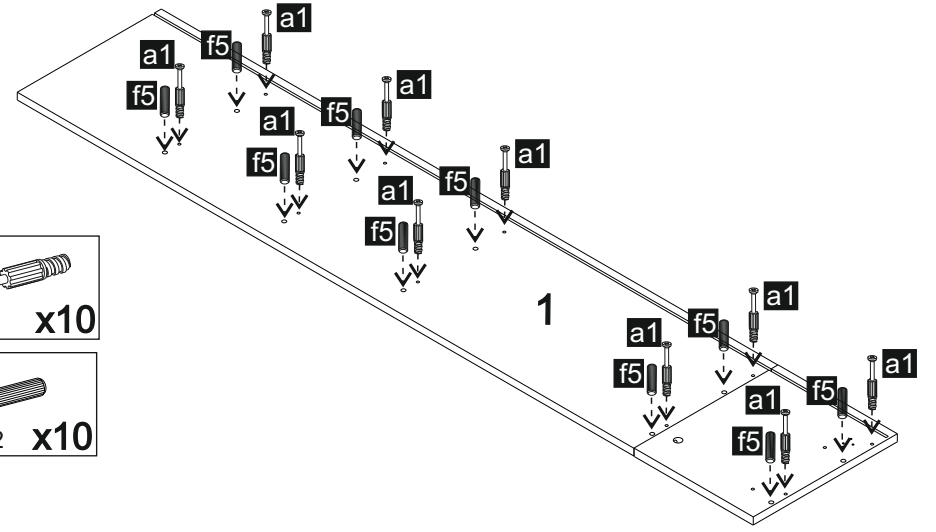
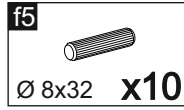
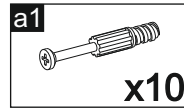

2

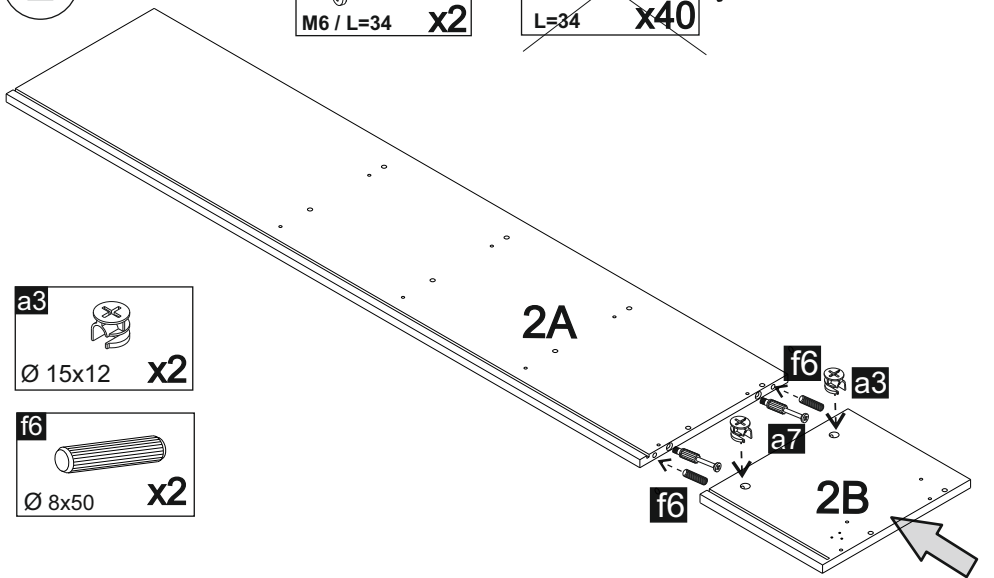
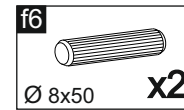
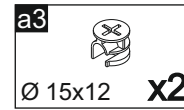
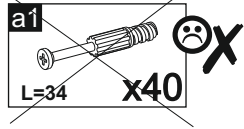
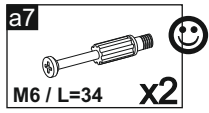

4

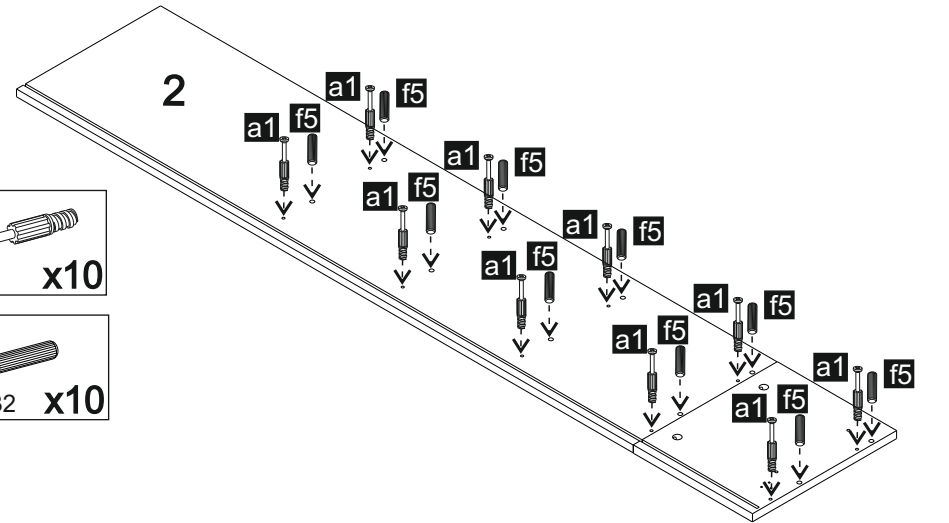
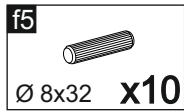
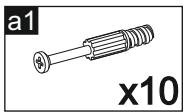

5

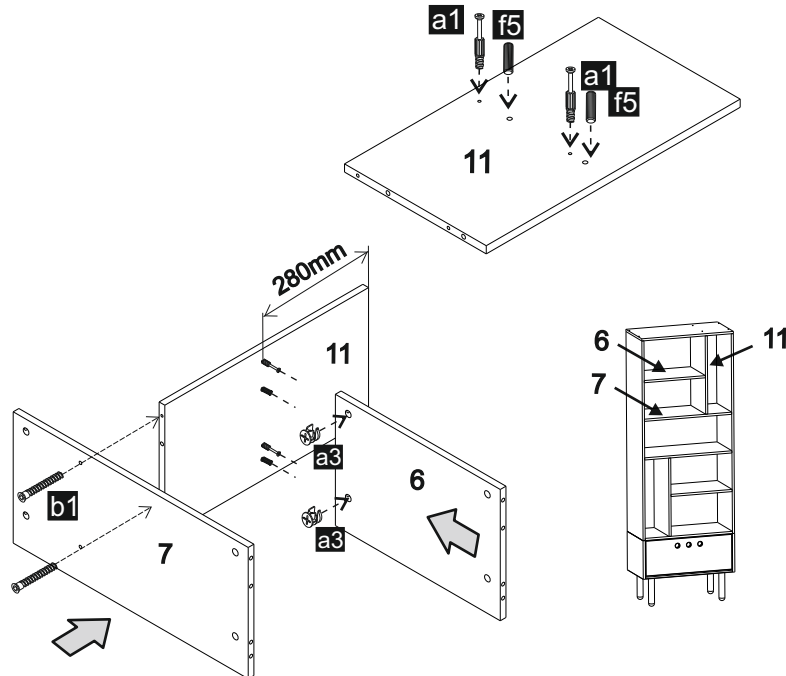
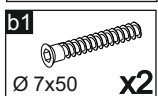
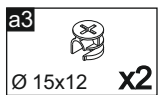
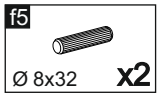
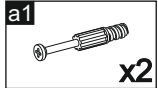

7

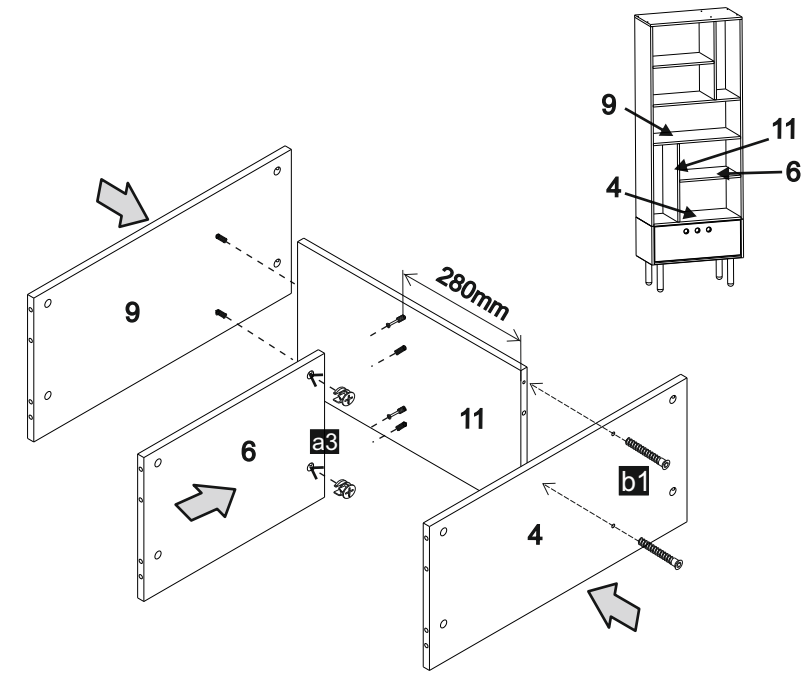
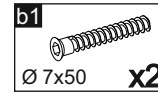

6

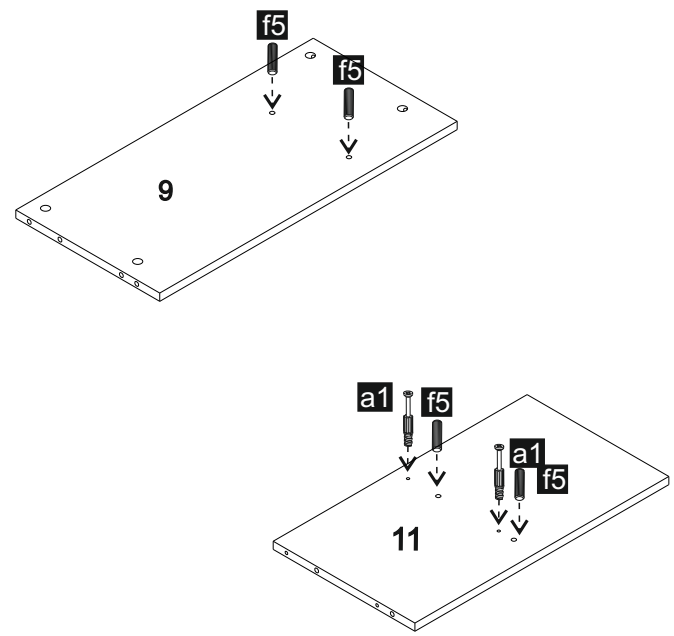
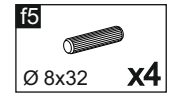
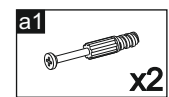

8

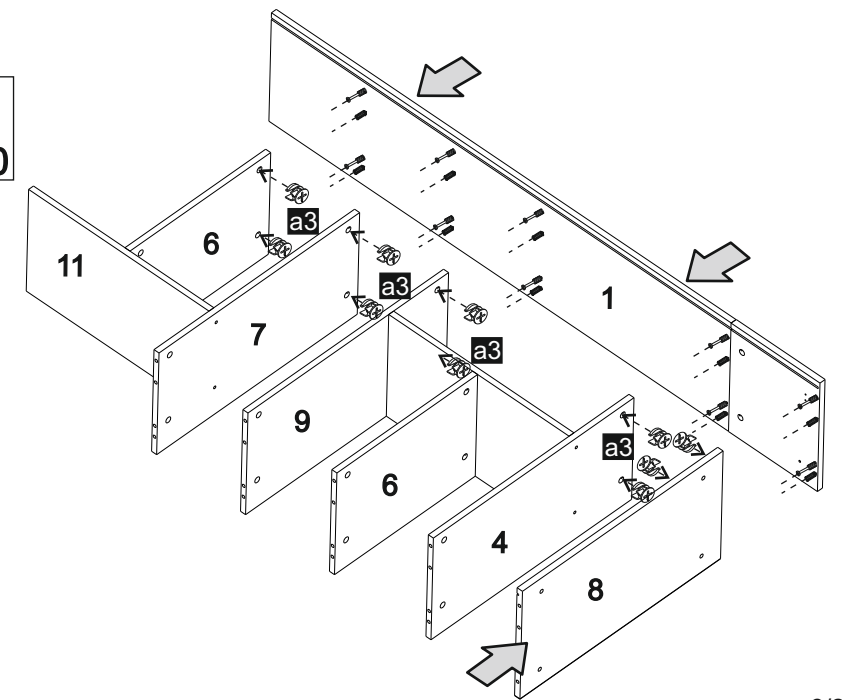
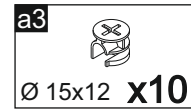

9

a3
Ø 15x12 x10

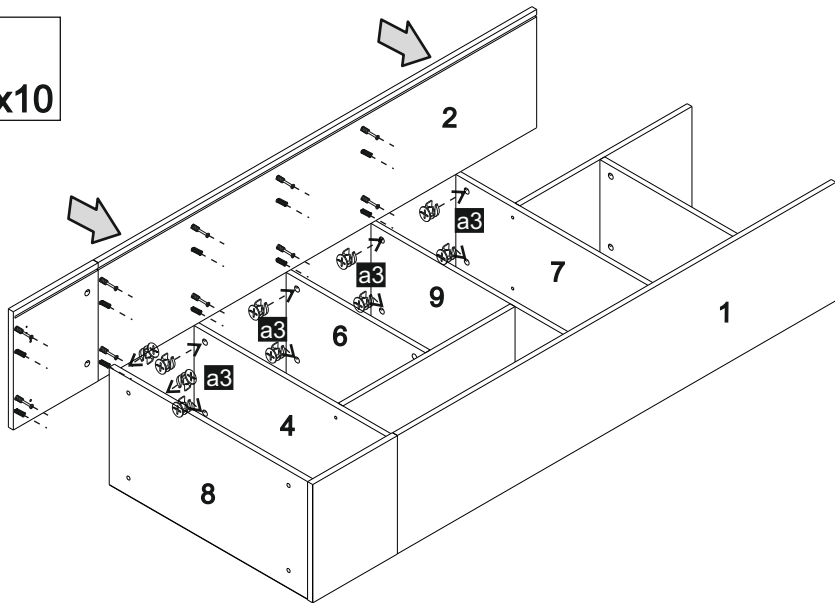

11

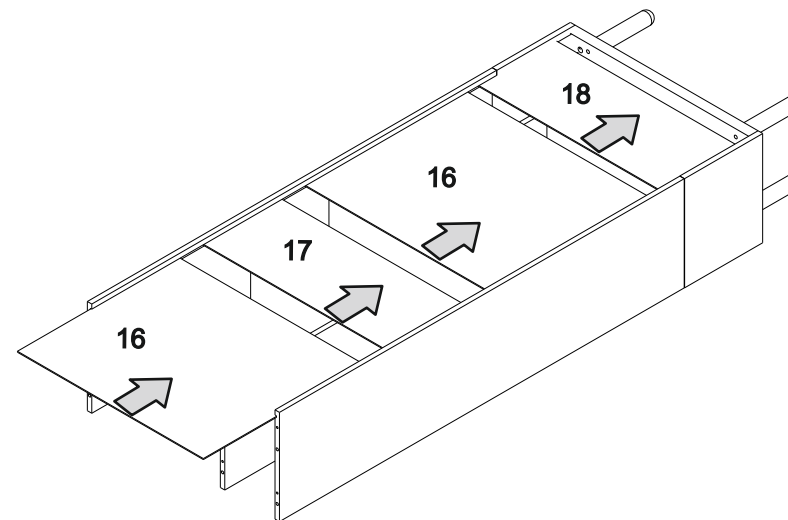

10

h18
Ø 8x40 x4

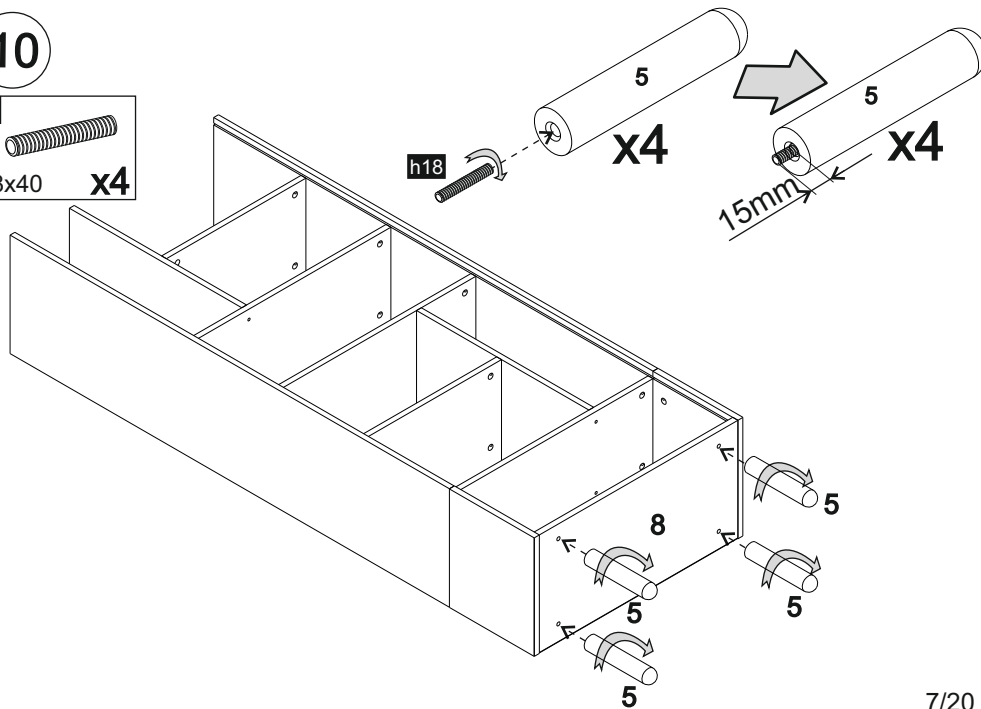

12

f5
Ø 8x32 x6

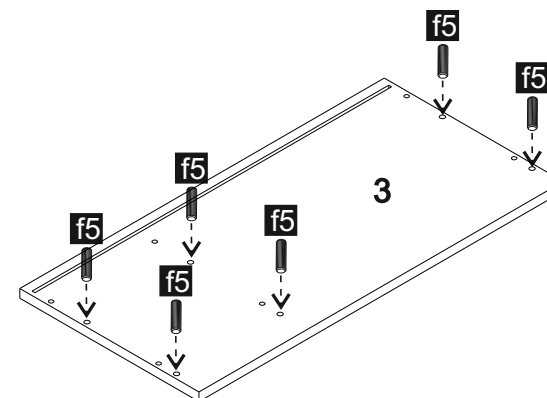

13

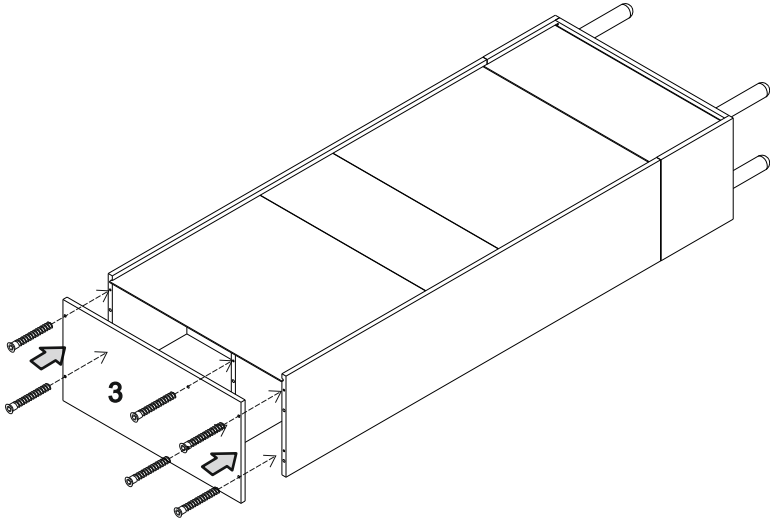
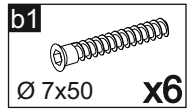

15

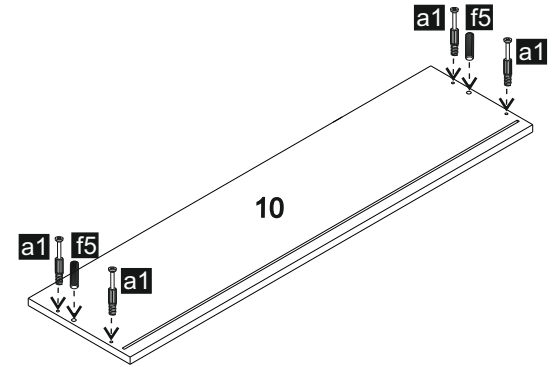
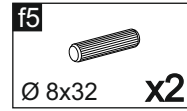
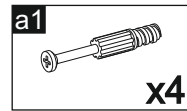

14

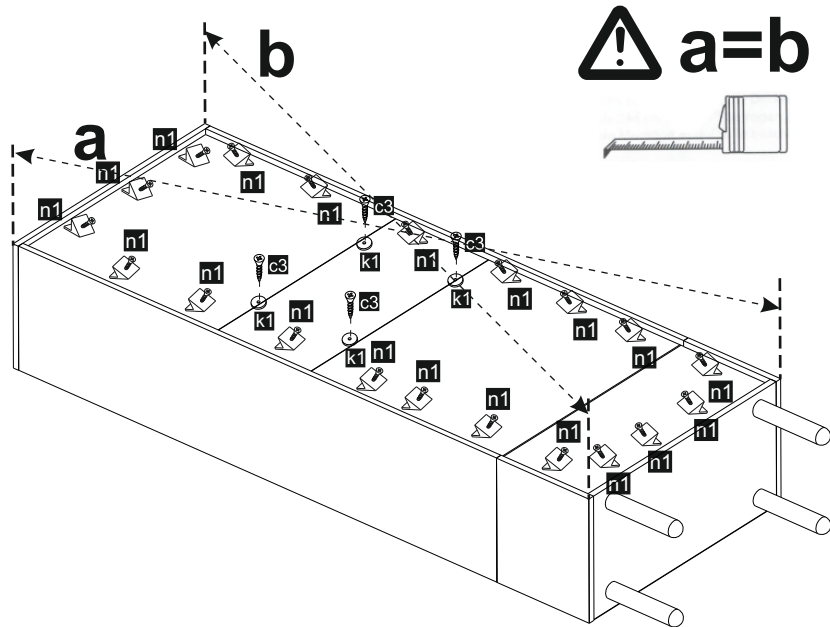
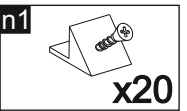
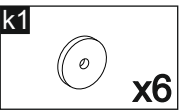
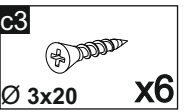

16

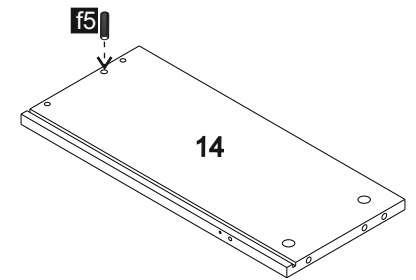
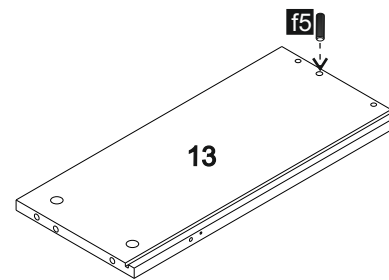
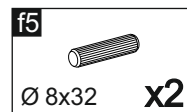

17

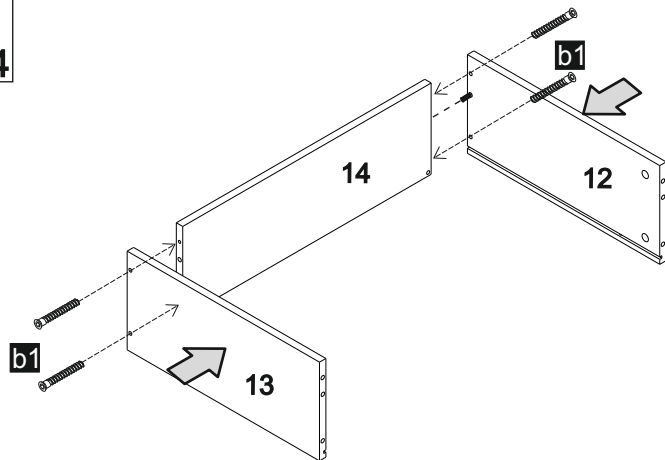
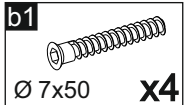

19

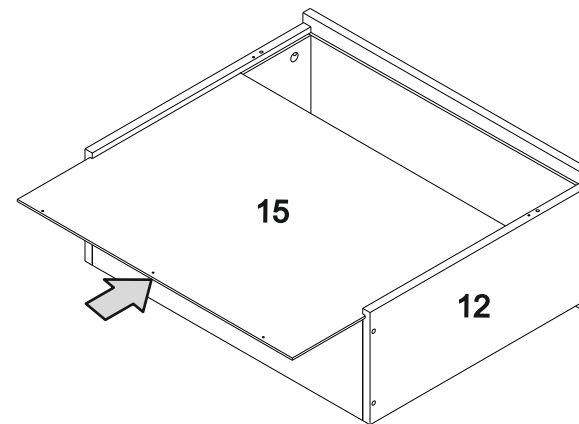

18

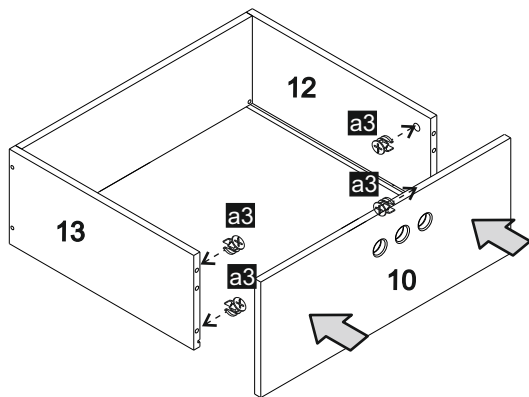
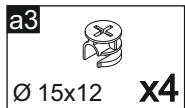

20

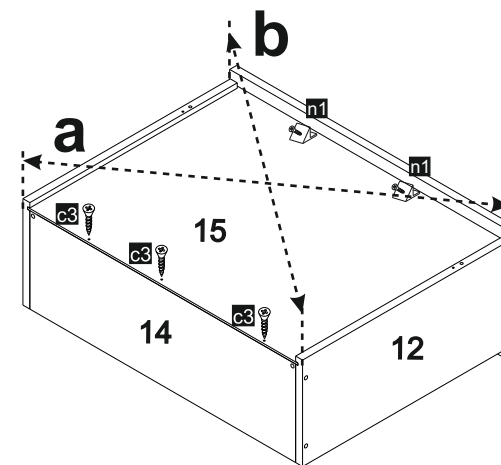
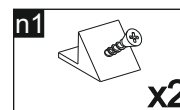
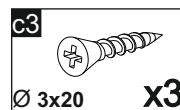

! a=b



21

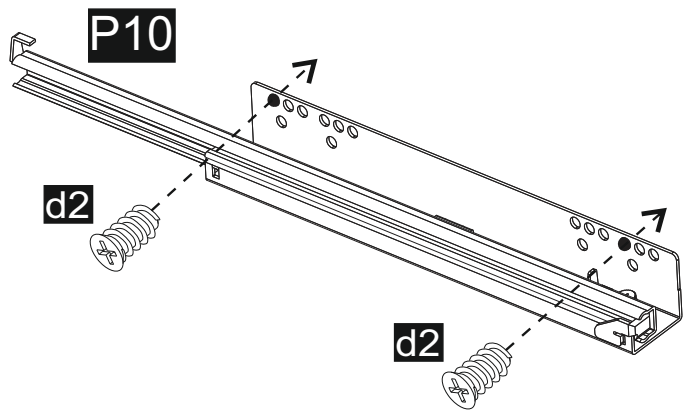
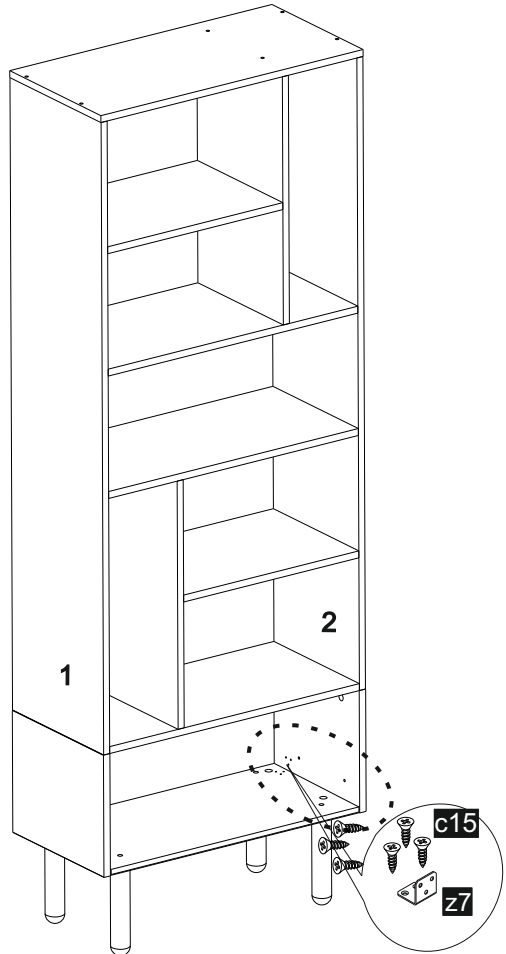
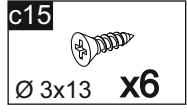
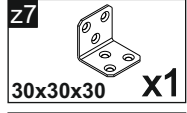
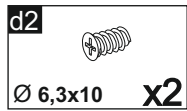
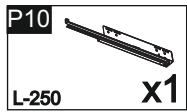

22

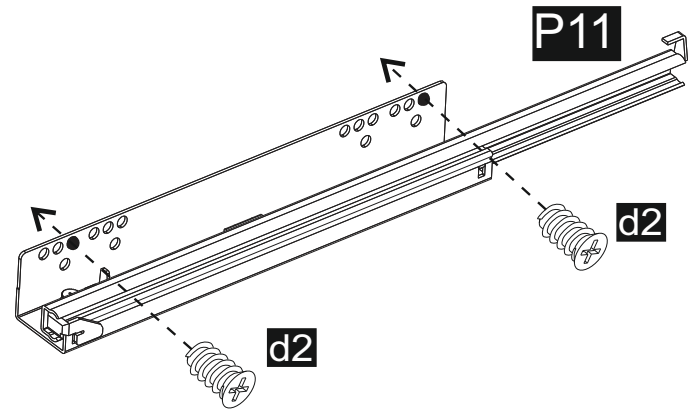
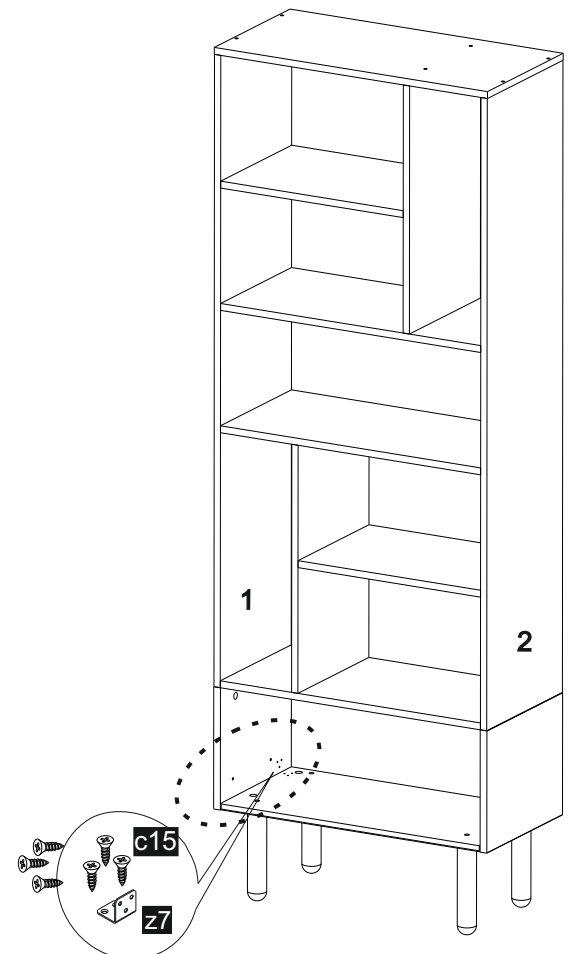
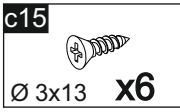
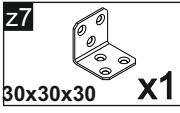
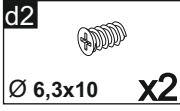
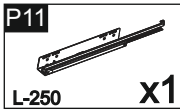

23

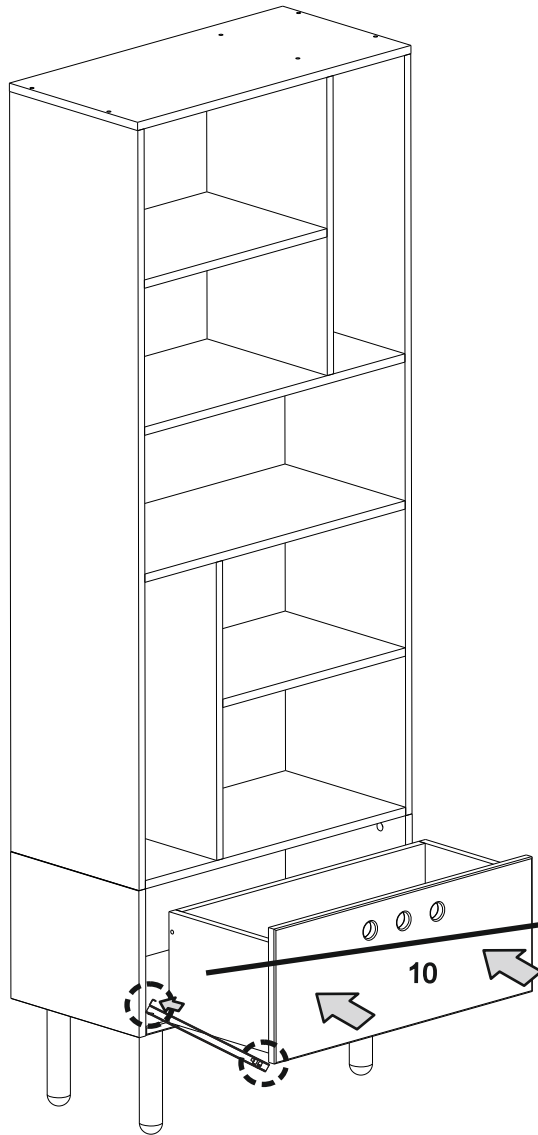
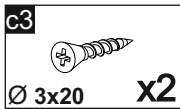

24

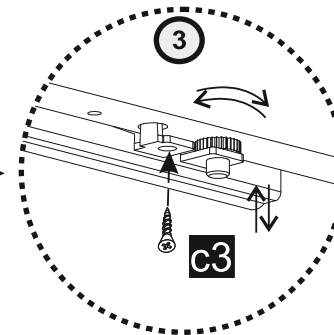
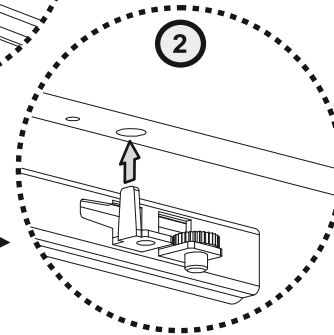
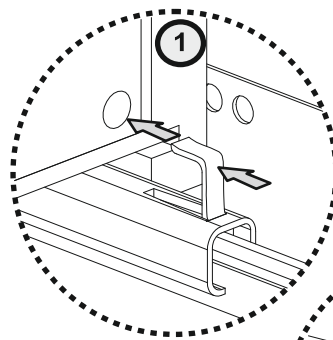
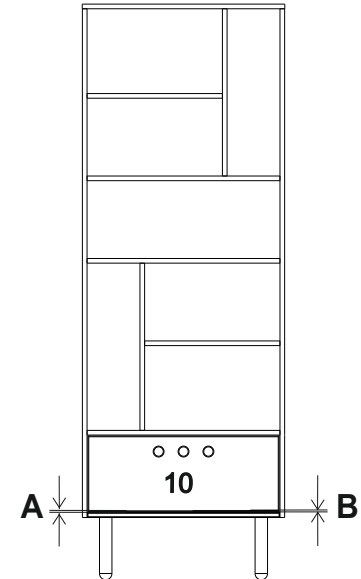
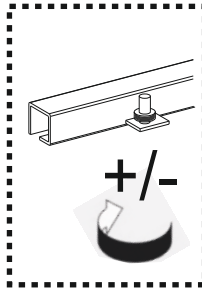

25

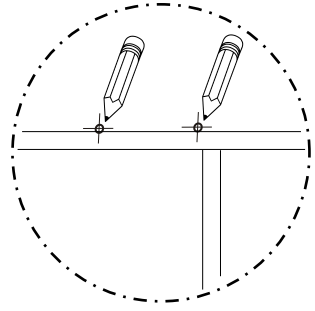
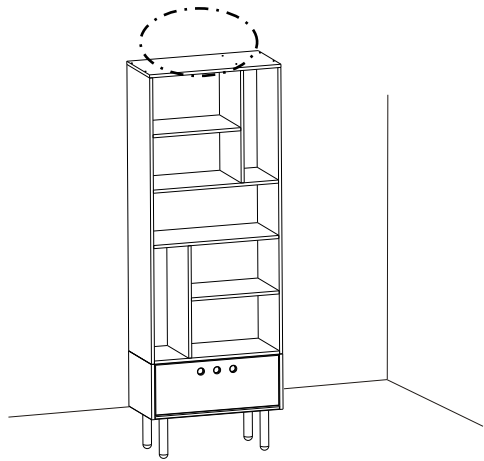

27

c12

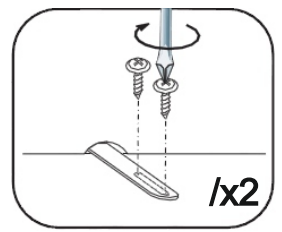
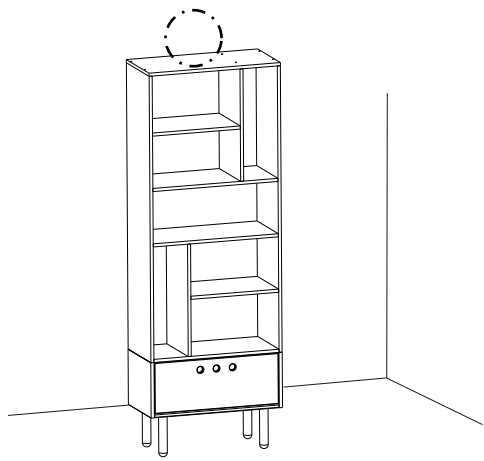
 Ø 3,5x13 x4

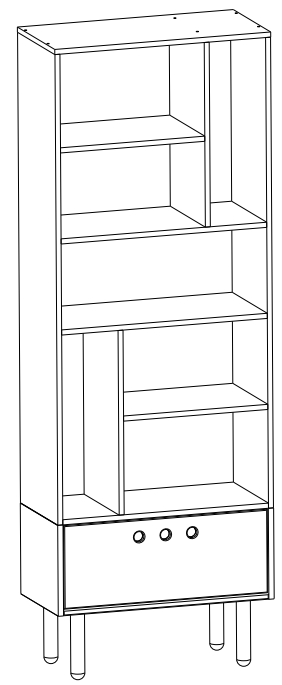
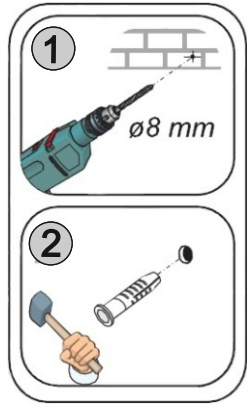
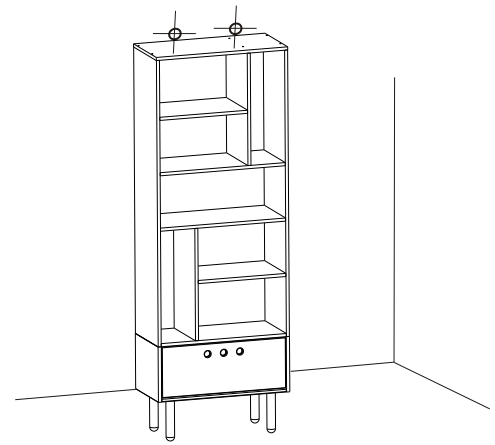

26

o2

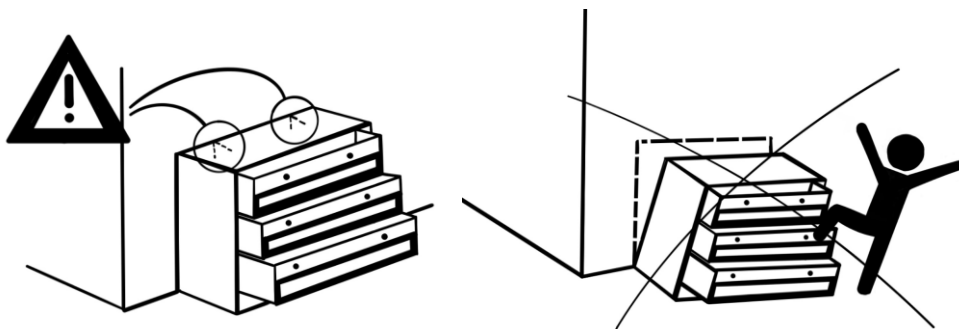
 x2





Fasten it!

We all want our homes to be safe. Unfortunately, accidents can occur in homes where children are particularly vulnerable. The best way to prevent a piece of furniture from falling over is to attach it to the wall.

How to prevent accidents caused by furniture falling over?

- Fasten it! Furniture should be securely attached to the wall. Use the anti-tipping fixing attached to the product, as well as screws and dowels appropriate for the type of wall. Take a look at the attached guide, which will help you choose them.
- Never allow children to climb or hang on drawers, doors or shelves.

Fasten it! Wall mounting guide. Furniture should be securely attached to the wall.

Due to different wall types, the customer chooses the type of attachment for the wall. If the material from which the walls are made in your home is not included below or you have additional questions, contact the selected store with building materials.

Building material

1. Drywall or plaster wall with timber frame- fig.1
2. A drywall wall without a timber frame- fig.2
3. Brick wall:
 - solid wall (fig. 3a)
 - wall with empty space inside (fig. 3b)



Rysunek 1



Rysunek 2



Rysunek 3a i 3b

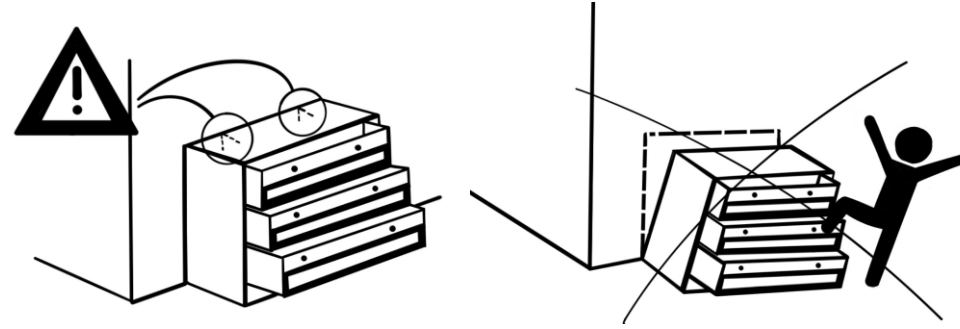

Przymocuj to!

Wszyscy chcemy, żeby nasze domy były bezpieczne. Niestety w domach mogą zdarzyć się wypadki, na które szczególnie narażone są dzieci. Najlepszym sposobem, by zapobiec przewróceniu się mebla, jest przymocowanie go do ściany.

Jak zapobiec wypadkom spowodowanym przewróceniem się mebli?

- Przymocuj to! Meble należy bezpiecznie przymocować do ściany. Wykorzystaj mocowanie zapobiegające przewróceniu się mebla dołączone do produktu oraz śruby i kołki odpowiednie do danego typu ściany. Zajrzyj do załączonego poradnika, który pomoże Ci je dobrać.
- Nigdy nie pozwalaj dzieciom wspinać się lub wieszać na szufladach, drzwiczkach czy półkach.

Przymocuj to! Poradnik dotyczący mocowania do ściany. Meble należy bezpiecznie przymocować do ściany.

Ze względu na różne ściany klient sam dobiera rodzaj mocowania do danej ściany. Jeśli poniżej nie uwzględniono materiału, z którego wykonane są ściany w twoim domu lub masz dodatkowe pytania, skontaktuj się z wybranym sklepem z materiałami budowlanymi.

Materiał budowlany

1. Ściana suchej zabudowy lub gipsowa ze szkieletem drewnianym- rys.1
2. Ściana suchej zabudowy bez szkieletu drewnianego- rys.2
3. Ściana murowana:
 - ściana lita (rys. 3a)
 - ściana z pustą przestrzenią wewnątrz (rys. 3b)



Rysunek 1



Rysunek 2



Rysunek 3a i 3b

