

Babushka

Łóżko 90x200

wood luck

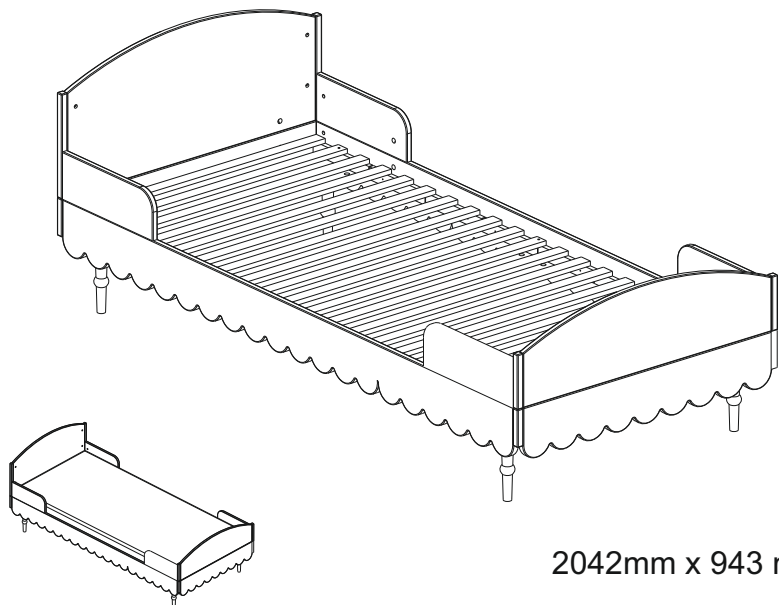

2042mm x 943 mm x 771 mm

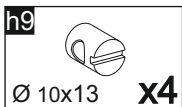
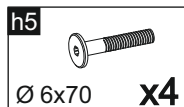
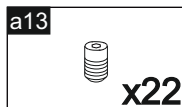
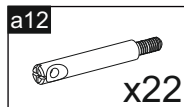
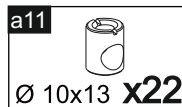
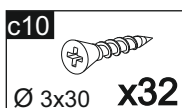
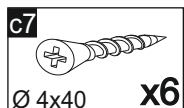
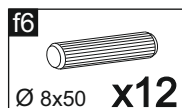
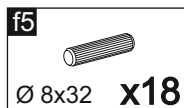
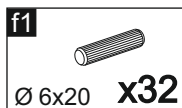
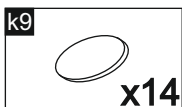
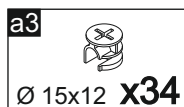
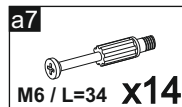
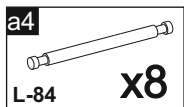
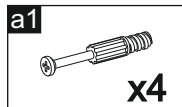
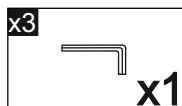
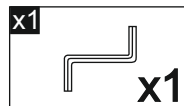
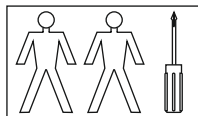

MONTOWAĆ NA MIĘKKIM PODŁOŻU, ABY NIE USZKODZIĆ ELEMENTÓW

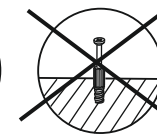
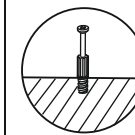
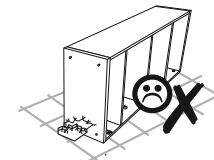
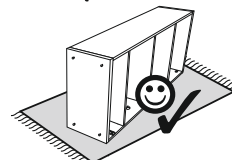

ASSEMBLE ON A SOFT SURFACE TO AVOID DAMAGING THE COMPONENTS

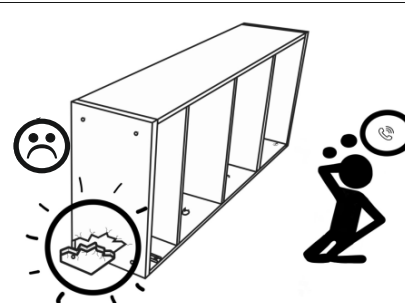
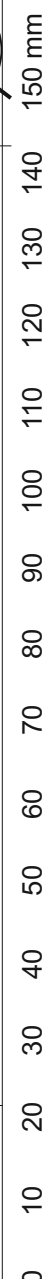
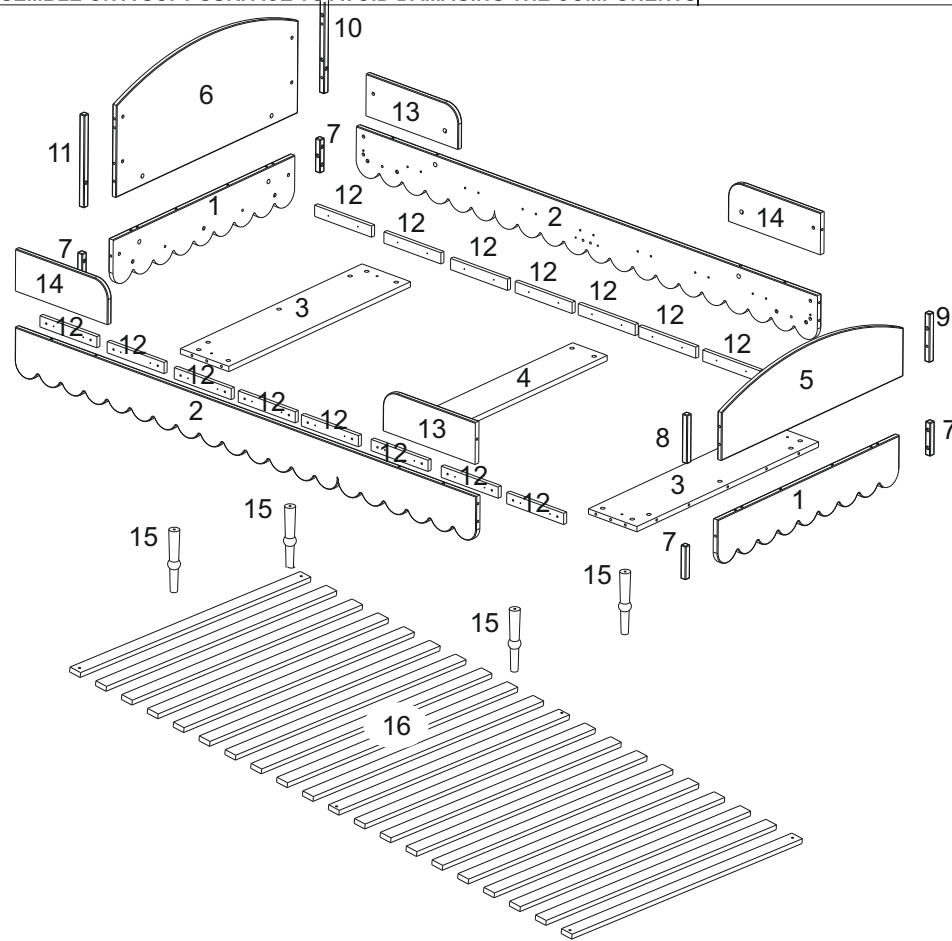

**przed montażem mebli,
sprawdzić elementy!
before assembling,
check the components!**

1

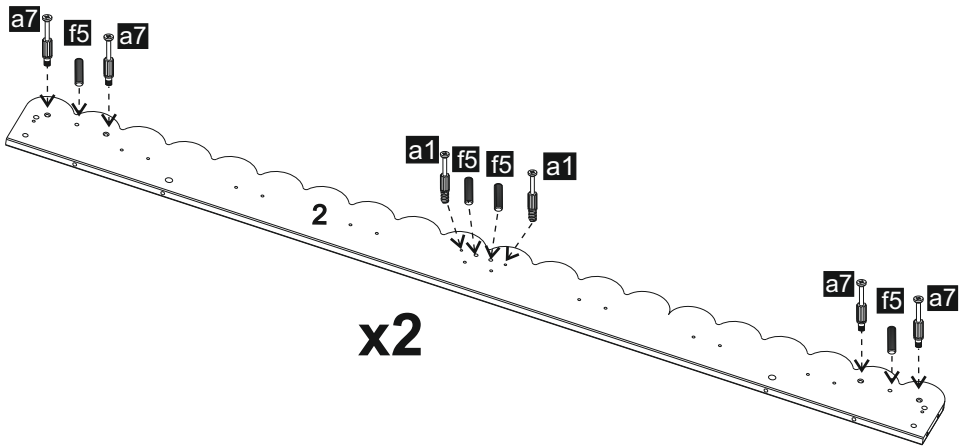
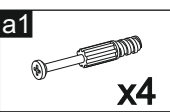
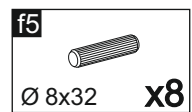
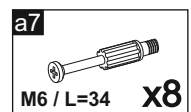

3

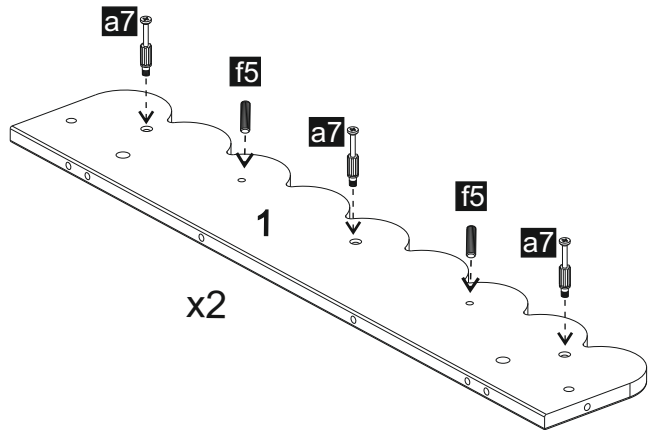
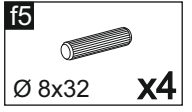
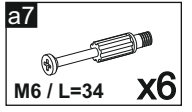

2

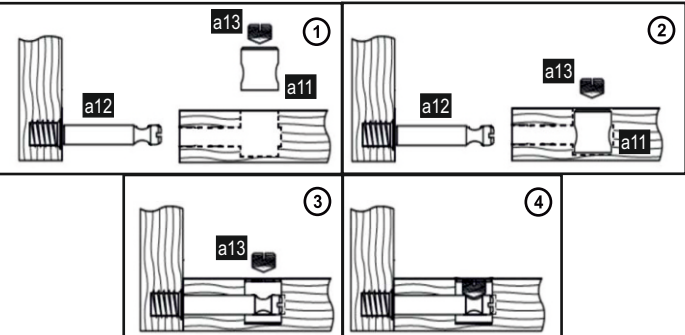
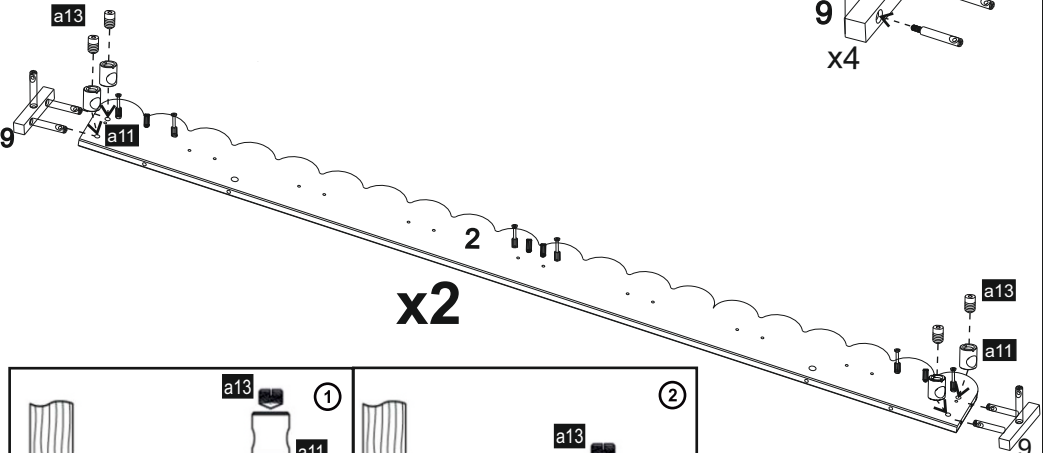
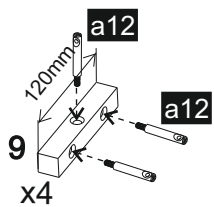
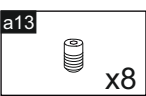
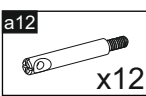
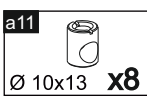

4

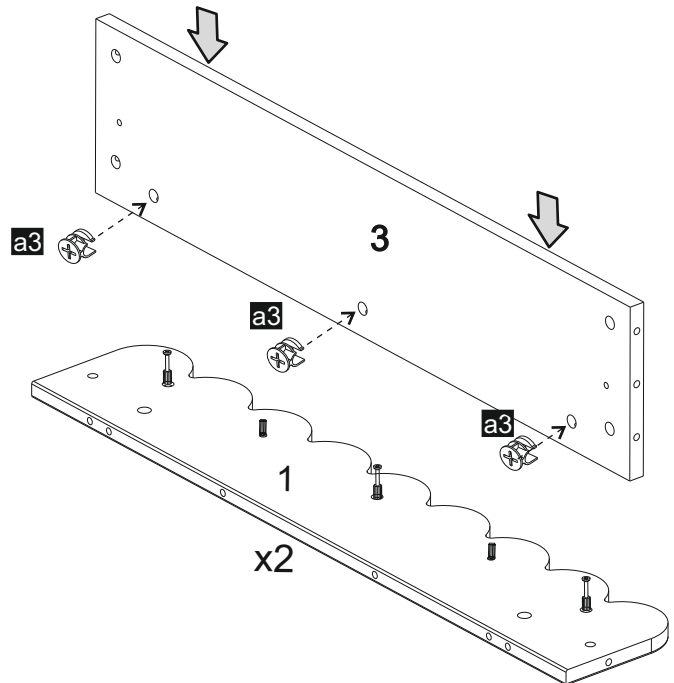
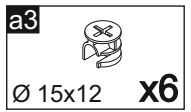

5

a11
Ø 10x13 x2

a13
x2

a3
Ø 15x12 x6

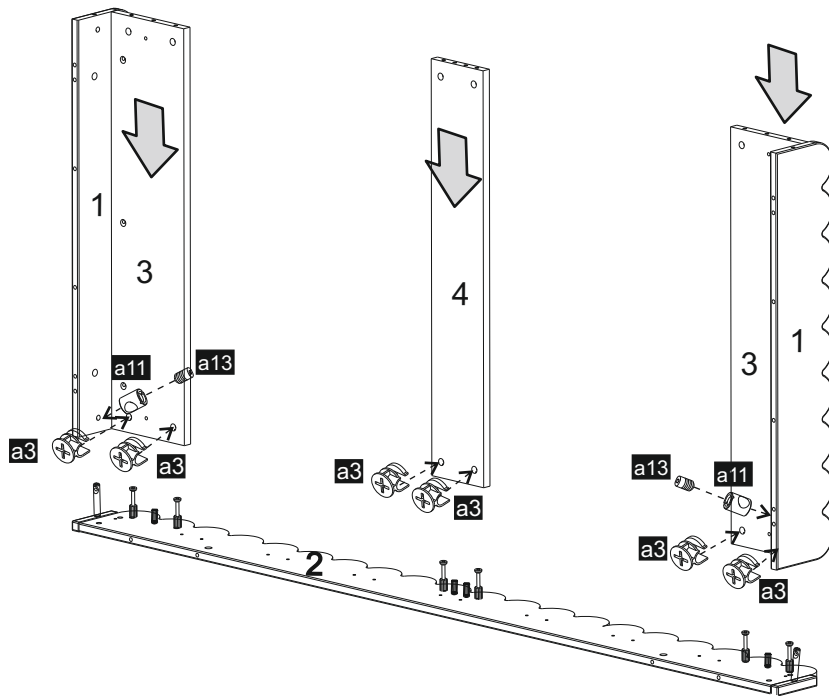

7

c10
Ø 3x30 x32

f1
Ø 6x20 x32

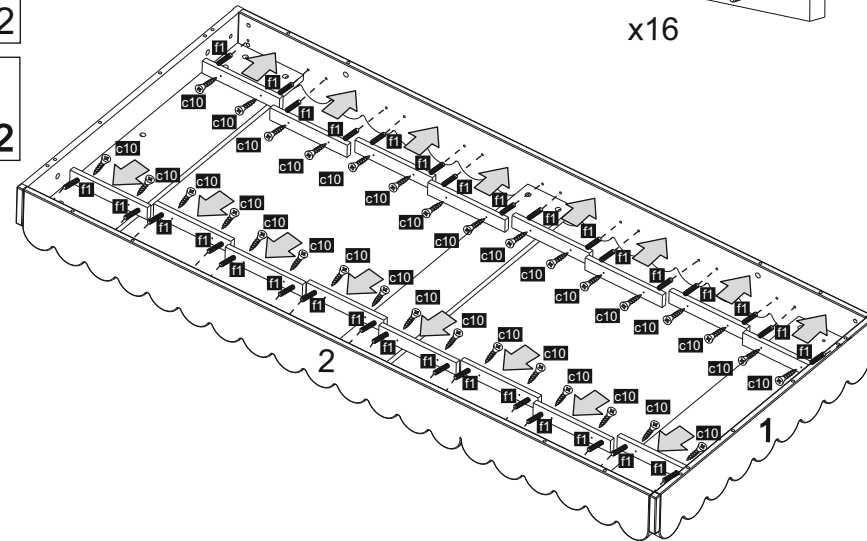
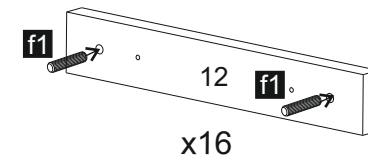

6

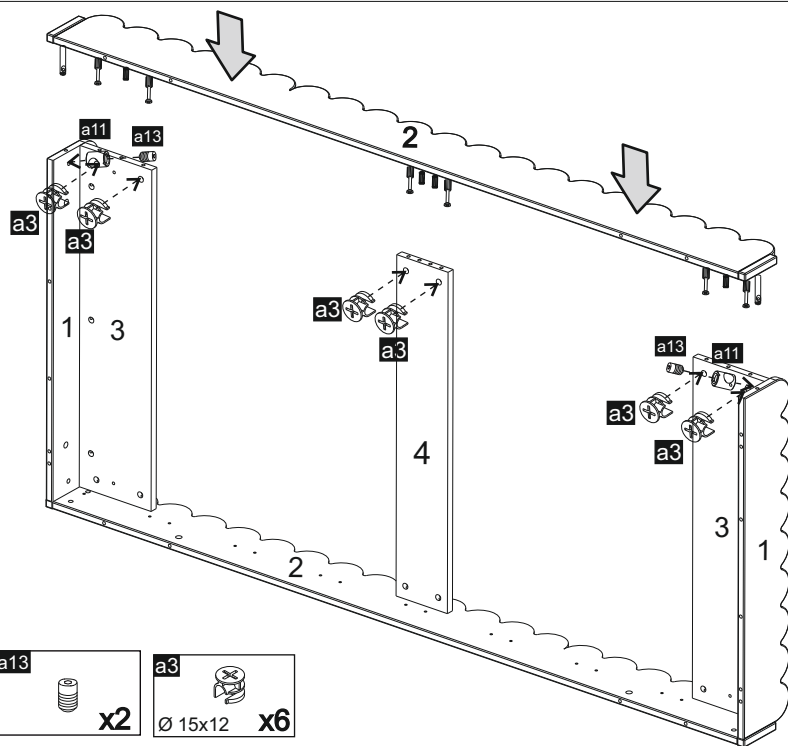

a11
Ø 10x13 x2

a13
x2

a3
Ø 15x12 x6

5/10

8

h5
Ø 6x70 x4

h9
Ø 10x13 x4

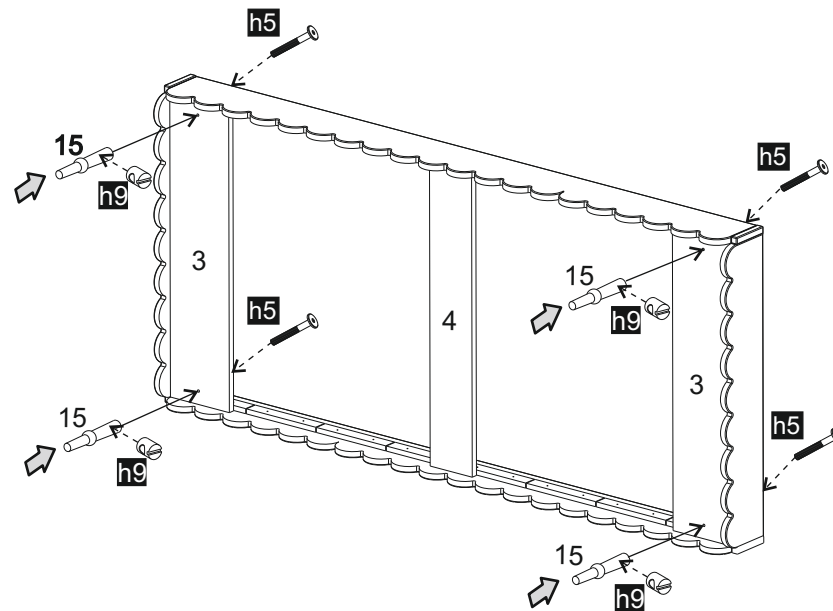

6/10

9

a3  $\varnothing 15 \times 12$ **x8**

a4  **x8**
L-84

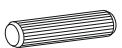
f6  **x12**
 $\varnothing 8 \times 50$

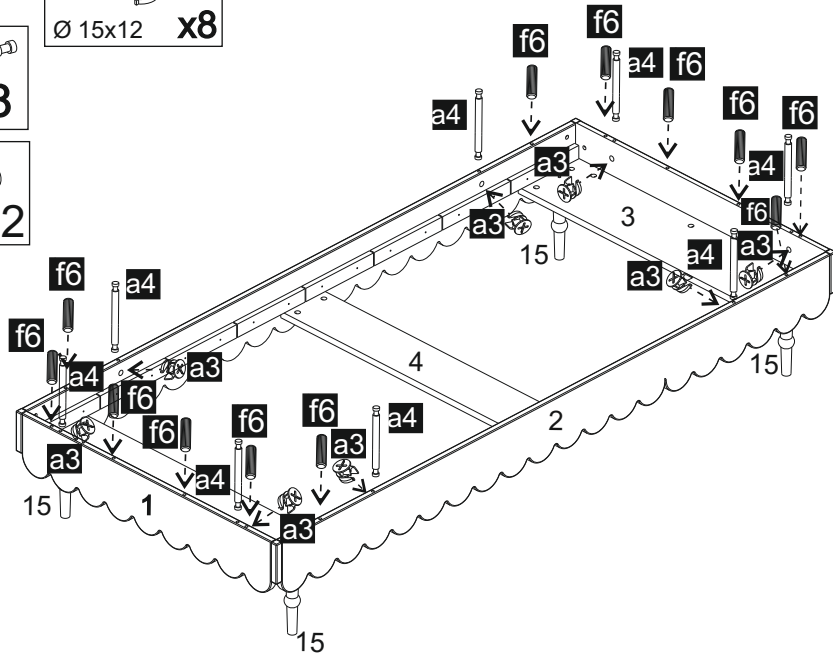

11

a11  **x2**
 $\varnothing 10 \times 13$

a13  **x2**

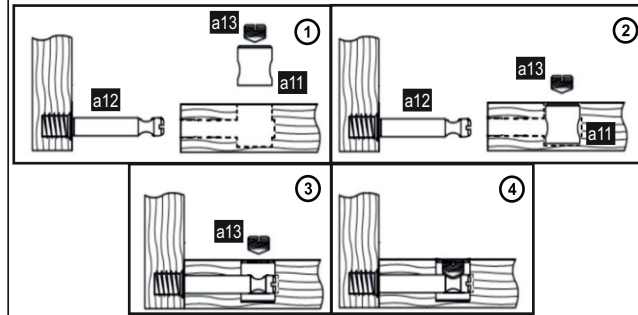
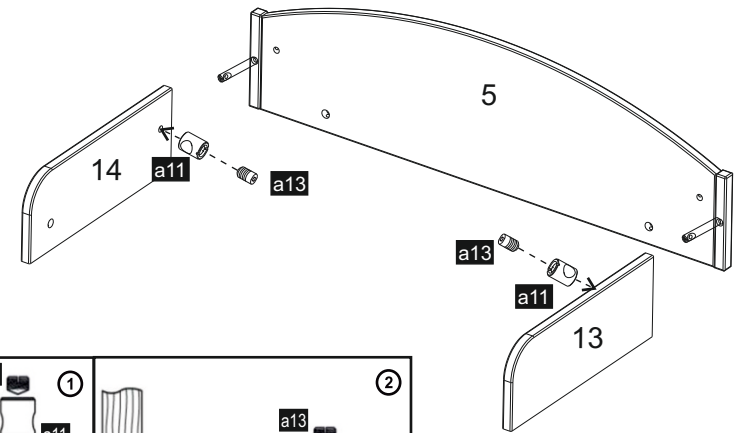

10

a12  **x4**

a11  **x2**
 $\varnothing 10 \times 13$

a13  **x2**

f5  **x2**
 $\varnothing 8 \times 32$

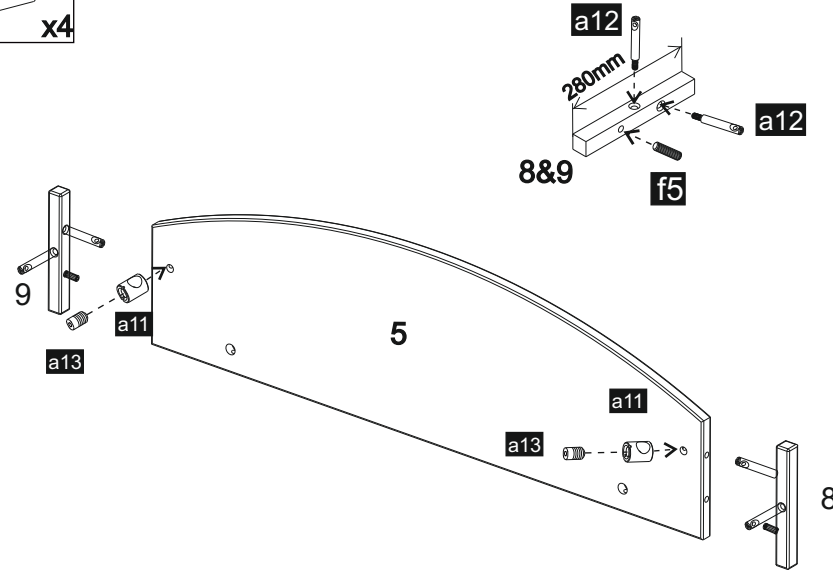

12

a12  **x6**

a11  **x4**
 $\varnothing 10 \times 13$

a13  **x4**

f5  **x4**
 $\varnothing 8 \times 32$

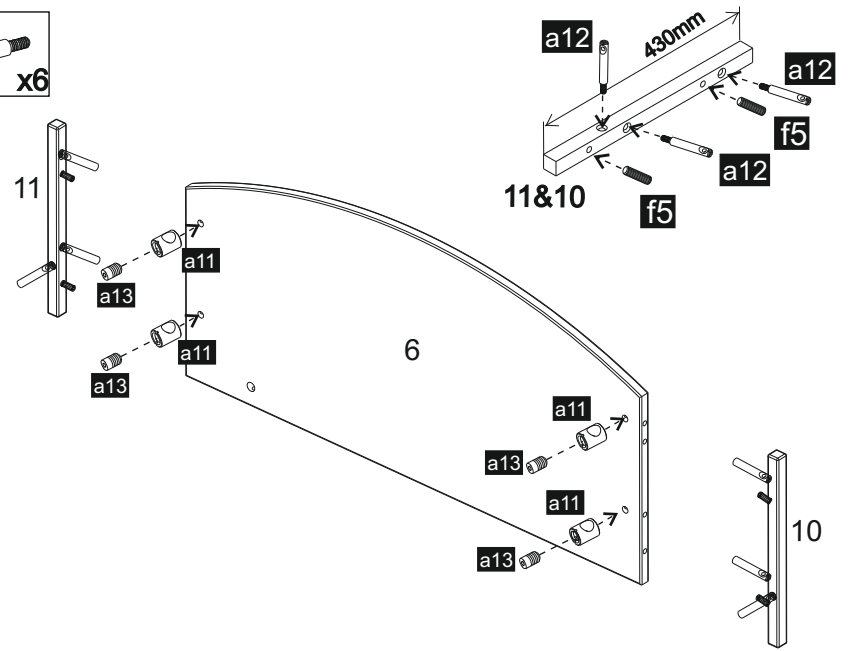

13

a11
Ø 10x13 x2

a13
x2

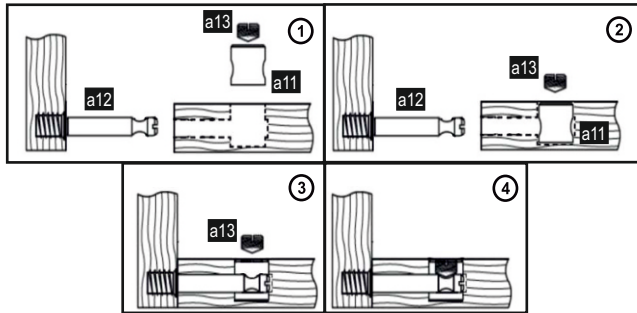
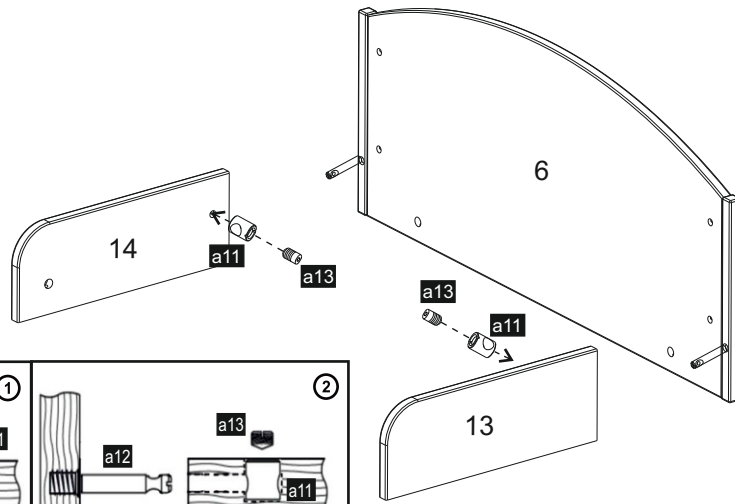

15

a3
Ø 15x12 x4

k9
x14

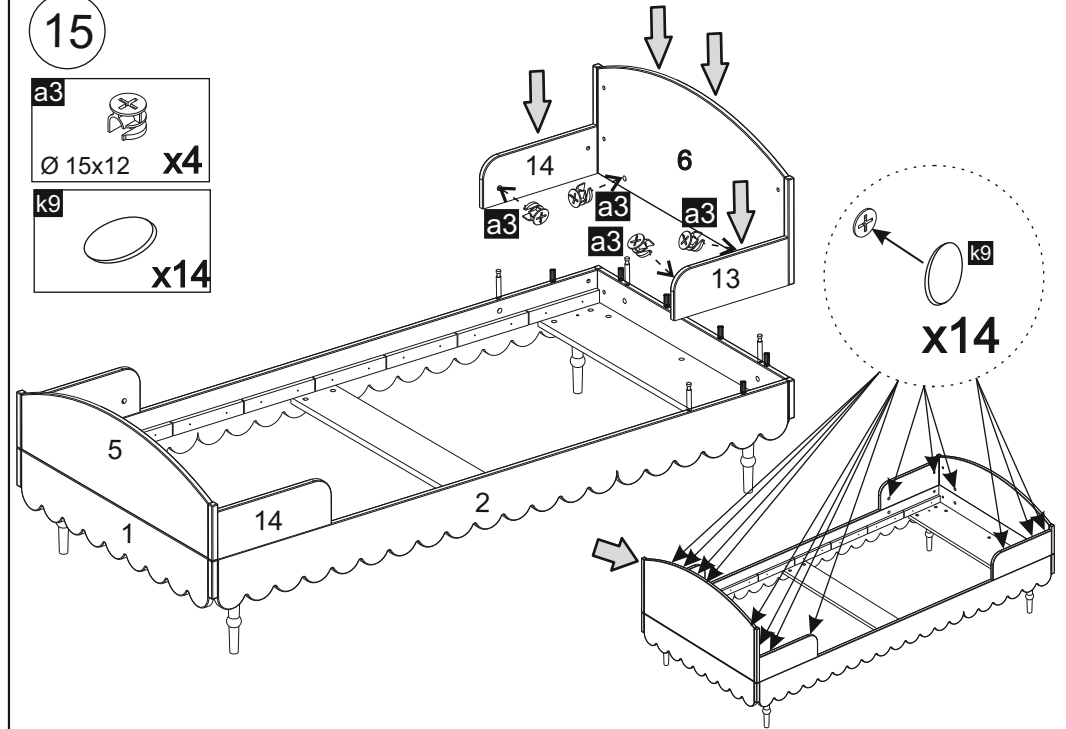

14

a3
Ø 15x12 x4

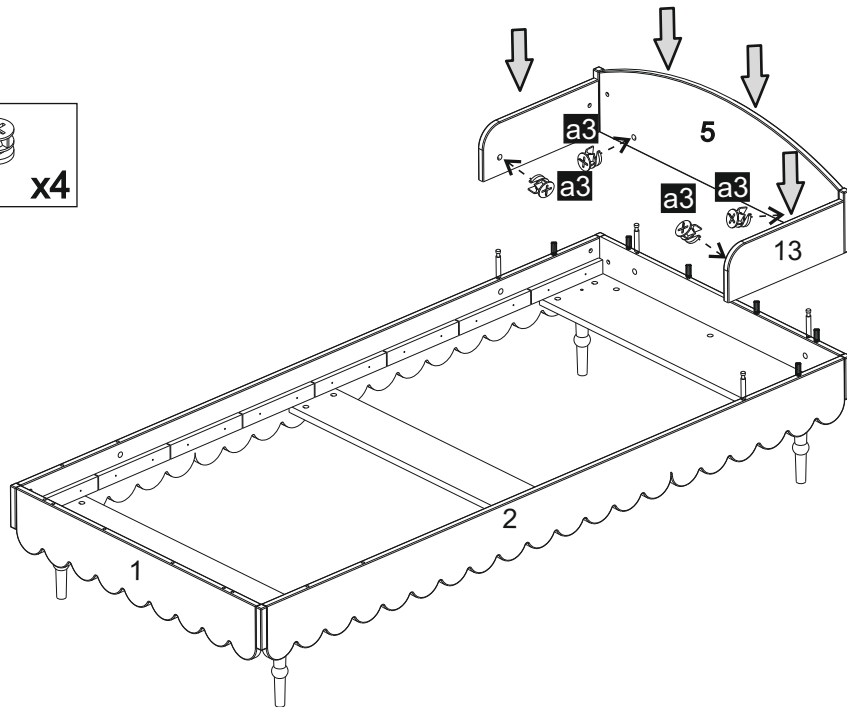

16

c7
Ø 4x40 x6

